

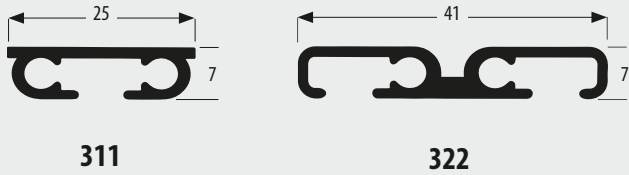

## Schnurzugschienen





### TECHNISCHE EIGENSCHAFTEN

**FARBEN:** Profil in Weiß.

**BEFESTIGUNG:** Alle 24 cm vorgebohrt.

**BIEGERADIUS:** Ab 100 cm Radius geeignet für Montage im Bogenfenster.

### GARNITUREN 311

Inkl.

- ▶ Gleiter 4263
- ▶ Haken 605
- ▶ Feststeller 4277
- ▶ Überlaufwagen 4185
- ▶ Montage-Clip 4388
- ▶ Schnurhalter 8003

### GARNITUREN 322

Inkl.

- ▶ Gleiter 4263
- ▶ Haken 605
- ▶ Feststeller 4277
- ▶ Schnurhalter 8003
- ▶ Schrauben 4390



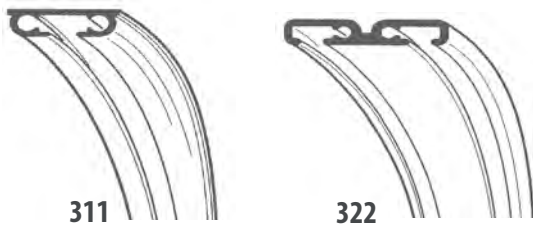







BREITE CM	ANZAHL GLEITER
200	32
210	34
220	36
230	37
240	39
250	40
260	42
270	44
280	45
290	46
300	48
310	50
320	52
330	53
340	54
350	56
360	58
370	60
380	61
390	63
400	64
410	66
420	68
430	69
440	71
450	72
460	74
470	76
480	77
490	79
500	80
510	82
520	84
530	85
540	87
550	88
560	90
570	92
580	93
590	95
600	96



### BELASTUNGSTABELLE

KG	Mit Gleiter 4263	Meter			Mit Gleiter 4263	Meter		
		2	4	6		2	4	6
		4	4	4		3	3	3

		ART. NR.	VPE
	Weiß	311	1 x 6 m
	Überlaufwagen	4185	1
	Schrauben 2,9 x 30 mm mit Dübel	4392	100
	Montage-Clip Metall	4388	1
	Schnur- und Kettenhalter Transparent	8003	1
	Schnurbeschwerer 230 g	5001	1
	Schnurspanner Kunststoff Weiß	8002	1
	Schnurspanner Metall Weiß	8001	1
	Stopper mit Metallkralle (6 mm)	4277	10
	Verschlussstopfen (6 mm)	918L	10
	Gleiter 10 Stück auf Stange (6 mm) Weiß	4263	100
	Spalthaken	605	100
	Einfachhaken	385	100
	Gelenkgleiter (6 mm)	926	100

		ART. NR.	VPE
	Weiß	322	1 x 6 m
	Schrauben 4,0 x 40 mm mit Dübel und Abdeckkappe	4390	100
	Stopper mit Metallkralle (6 mm)	4277	10
	Verschlussstopfen (6 mm)	918L	10
	Schnurspanner Kunststoff Weiß	8002	1
	Schnurspanner Metall Weiß	8001	1
	Gleiter 10 Stück auf Stange (6 mm) Weiß	4263	100
	Spalthaken	605	100
	Einfachhaken	385	100
	Gelenkgleiter (6 mm)	926	100

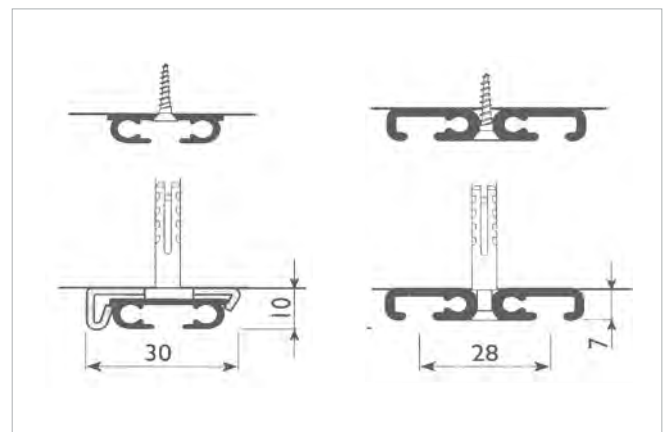

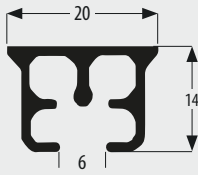

### TECHNISCHE EIGENSCHAFTEN

**FARBEN:** Weiß pulverbeschichtet.  
**BEFESTIGUNG:** Mittels Deckenclipl.  
**MONTAGEPUNKTE:** Alle 30 – 40 cm.

### GARNITUREN

Inkl.	
▶ Deckenclip	1605
▶ Haken	605
▶ Gleiter	4263
▶ Feststeller	4277
▶ Überlaufwagen	4185
▶ Schnurhalter	8003

### GARNITUREN WAVE

Inkl.	
▶ WAVE Gleiterkette	8971
▶ WAVE Gleiterabstand	8 cm
▶ WAVE Bügel (für erste und letzte Falte)	8974
▶ Deckenclip	1605
▶ Feststeller	4277
▶ Haken	8971
▶ Überlaufwagen	4185
▶ Schnurhalter	8003

Die Menge der Gleiter erfolgt immer in gerader Anzahl.

BREITE CM	ANZAHL GLEITER	WAVE ANZAHL GLEITER
200	32	26
210	34	28
220	36	28
230	37	30
240	39	30
250	40	32
260	42	34
270	44	34
280	45	36
290	46	38
300	48	38
310	50	40
320	52	40
330	53	42
340	54	44
350	56	44
360	58	46
370	60	48
380	61	48
390	63	50
400	64	50
410	66	52
420	68	54
430	69	54
440	71	56
450	72	58
460	74	58
470	76	60
480	77	60
490	79	62
500	80	64
510	82	64
520	84	66
530	85	68
540	87	68
550	88	70
560	90	70
570	92	72
580	93	74
590	95	74
600	96	76

### BELASTUNGSTABELLE

KG	Mit Gleiter 4263	Meter			Mit Gleiter 4263	Meter		
		2	4	6		2	4	6
		5	5	5		3	3	3

		ART. NR.	VPE
	Weiß	1600	1 x 6 m
	Deckenträger	1104	1
	Abdeckkappe Deckenträger	1105	1
	Deckenclip	1605	1
	Überlaufwagen	4185	1
	Schnur- und Kettenhalter Transparent	8003	1
	Schnurbeschwerer 230 g	5001	1
	Stopper mit Metallkralle (6 mm)	4277	10
	Verschlussstopfen (6 mm)	918L	10
	Schnurspanner Kunststoff Weiß	8002	1

		ART. NR.	VPE
	Schnurspanner Metall Chrom Weiß	8000 8001	1 1
	Schnurbeschwerer 180 g Weiß	4001	1
	Gleiter 10 Stück auf Stange (6 mm) Weiß	4263	100
	Spalthaken	605	100
	Einfachhaken	385	100
	Gelenkgleiter (6 mm)	926	100

**WAVE ZUBEHÖR**

	WAVE Band	8970	1 m 50 m
	WAVE Haken für Band 8970	8973	100
	WAVE Sinus Gleiterkette mit drehbarer Öse Weiß	8980	1 m 100 m
	WAVE Sinus Gleiter für erste und letzte Falte	8974	1





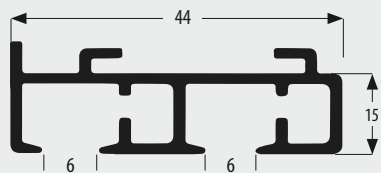

### TECHNISCHE EIGENSCHAFTEN

**FARBEN:** Weiß pulverbeschichtet.

**BEFESTIGUNG:** Mittels Spannriegel.

**MONTAGEPUNKTE:** Alle 40 – 60 cm.

**SONSTIGES:** Kugelgelagerte Umlenkrollen aus stoßfestem Thermoplast

**HINWEIS:** Schiene kann nicht gebogen werden!

### GARNITUREN



















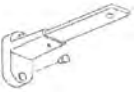

Inkl.

▶ Gleiter	4263
▶ Haken	605
▶ Spannriegel	4161
▶ Stopper	4211
▶ Schnurhalter	8003

BREITE CM	ANZAHL GLEITER
200	32
210	34
220	36
230	37
240	39
250	40
260	42
270	44
280	45
290	46
300	48
310	50
320	52
330	53
340	54
350	56
360	58
370	60
380	61
390	63
400	64
410	66
420	68
430	69
440	71
450	72
460	74
470	76
480	77
490	79
500	80
510	82
520	84
530	85
540	87
550	88
560	90
570	92
580	93
590	95
600	96

### BELASTUNGSTABELLE

		Meter		
Mit Gleiter 4263		2	4	6
KG		4	6	6

		ART. NR.	VPE			ART. NR.	VPE
	Weiß/Alu	542 S	1 x 6 m		Schnurbeschwerer 230 g	5001	1
	Schnellspanner für zweiläufige Schiene	4161	1		Schnurbeschwerer 180 g Weiß	4001	1
	Profilverbinder für zweiläufige Schiene	4098	1		Haken Metall 20 mm	607	10
	Stopper mit Metallkralle (6 mm)	4277	10		Haken Metall 40 mm	608	10
	Wandträger 15 – 19 cm Weiß	7153	1		Spalthaken	605	100
	Grau	7152	1		Objektroller	996	100
	Winkel 10 cm 1-läufig Weiß	2031	1		Gleiter 10 Stück auf Stange (6 mm) Weiß	4263	100
	Wandträger Metall ausziehbar Weiß 100 - 150 mm	59312	1		Gelenkgleiter (6 mm)	926	100
	Verzinkt 100 - 150 mm	59313	1		Roller auf Nylonachse auf Stahlachse	4144	10
	Weiß 150 - 230 mm	59326	1		4330	10	
	Verzinkt 150 - 230 mm	59327	1		Schnur- und Kettenhalter Transparent	8003	1
	Abdeckkappe für Montage- winkel	2390	1				
	Schnurspanner Kunststoff Weiß	8002	1				
	Schnurspanner Metall Chrom	8000	1				
	Weiß	8001	1				

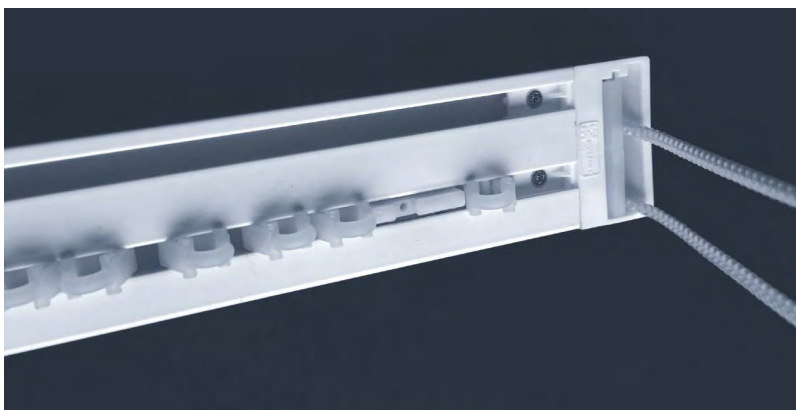

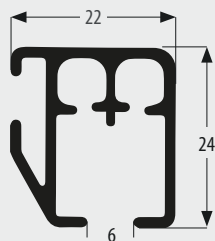

### TECHNISCHE EIGENSCHAFTEN

**FARBEN:** Weiß pulverbeschichtet und Silber E6 EV1 eloxiert.

**MONTAGEPUNKTE:** Alle 30 – 60 cm.

**BIEGERADIUS:** Kleinster Biegeradius bei 90° Bögen 13 cm.

**SONSTIGES:** Umlenkrollen aus stoßfestem Thermoplast mit Rollen auf Stahlachsen. Belastung laut Tabelle.

### GARNITUREN

Inkl.

- ▶ Roller 5010
- ▶ Haken 605
- ▶ Deckenträger 4081
- ▶ Feststeller 4277
- ▶ Überlaufwagen 4184
- ▶ Schnurhalter 8003

BREITE CM	ANZAHL ROLLER	BREITE CM	ANZAHL ROLLER
200	20	600	60
210	21	610	61
220	22	620	62
230	23	630	63
240	24	640	64
250	25	650	65
260	26	660	66
270	27	670	67
280	28	680	68
290	29	690	69
300	30	700	70
310	31	710	71
320	32	720	72
330	33	730	73
340	34	740	74
350	35	750	75
360	36	760	76
370	37	770	77
380	38	780	78
390	39	790	79
400	40	800	80
410	41		
420	42		
430	43		
440	44		
450	45		
460	46		
470	47		
480	48		
490	49		
500	50		
510	51		
520	52		
530	53		
540	54		
550	55		
560	56		
570	57		
580	58		
590	59		
600	60		

### BELASTUNGSTABELLE FÜR GERADE ANLAGEN

Jeder Bogen reduziert das Belastungsgewicht um 25 %.

	Mit Roller 5010	Meter				Mit Roller 5010	Meter			
		2	4	6	8		2	4	6	8
KG		7	10	8	6		4	4	3	2
		6	8	7	4		4	4	4	2



		ART. NR.	VPE			ART. NR.	VPE
	Weiß/Alu	490	1 x 6 m		Haken Metall 20 mm	607	10
	Deckenträger	4081	1		Haken Metall 40 mm	608	10
	Kombiträger	4083	1		Spalthaken	605	100
	Wandträger 5,5 cm 7,5 cm	4084 4085	1 1		Einfachhaken	385	100
	Profilverbinder	4589	1		Objektroller	996	100
	Wandträger 15 – 19 cm Weiß Grau	7153 7152	1 1		Gleiter 10 Stück auf Stange (6 mm) Weiß	4263	100
	Wandträger Metall ausziehbar Weiß 100 - 150 mm Verzinkt 100 - 150 mm Weiß 150 - 230 mm Verzinkt 150 - 230 mm	59312 59313 59326 59327	1 1 1 1		Gelenkgleiter (6 mm)	926	100
	Abdeckkappe für Montage- winkel Weiß/Grau	2390	1		Roller mit drehbarer Öse	5010	10
	Überlaufwagen	4184	1		Schwerlastroller mit Stahlachse	5011	10
	Schnurspanner Kunststoff Weiß	8002	1		Roller auf Nylonachse auf Stahlachse	4144 4330	10 10
	Schnurspanner Metall Chrom Weiß	8000 8001	1 1		Roller mit Gummirollen und Stahlachse	6011	10
	Schnurbeschwerer 230 g	5001	1		Schnur- und Kettenhalter Transparent	8003	1



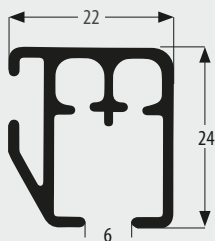

### GARNITUREN WAVE

Inkl.







- ▶ WAVE Gleiterkette 8971
- ▶ WAVE Gleiterabstand 8 cm
- ▶ WAVE Bügel (für erste und letzte Falte) 310
- ▶ Haken 8971
- ▶ Feststeller 4277
- ▶ Überlaufwagen 4184

Die Anzahl Gleiter erfolgt immer in geraden Schritten. Geben Sie uns ggf. Ihre Wunschmenge an Gleiter an.

WAVE		WAVE	
BREITE CM	ANZAHL GLEITER	BREITE CM	ANZAHL GLEITER
200	26	600	76
210	28	610	78
220	28	620	78
230	30	630	80
240	30	640	80
250	32	650	82
260	34	660	84
270	34	670	84
280	36	680	86
290	38	690	88
300	38	700	88
310	40	710	90
320	40	720	90
330	42	730	92
340	44	740	94
350	44	750	94
360	46	760	96
370	48	770	98
380	48	780	98
390	50	790	100
400	50	800	100
410	52		
420	54		
430	54		
440	56		
450	58		
460	58		
470	60		
480	60		
490	62		
500	64		
510	64		
520	66		
530	68		
540	68		
550	70		
560	70		
570	72		
580	74		
590	74		
600	76		

### BELASTUNGSTABELLE FÜR GERADE ANLAGEN

KG	Mit Gleiter 8971	Meter			
		2	4	6	8
		3	5	5	3

		ART. NR.	VPE		ART. NR.	VPE
	Weiß/Alu	490	1 x 6 m		WAVE Sinus Gleiter für erste und letzte Falte	310 1
	WAVE Band	8970	1 m 50 m		WAVE Haken für Band 8970	8973 100
	WAVE Sinus Gleiterkette (6 mm Lauf) Weiß	8971	1 m 100 m		Stopper mit Metallkralle (6 mm)	4277 10

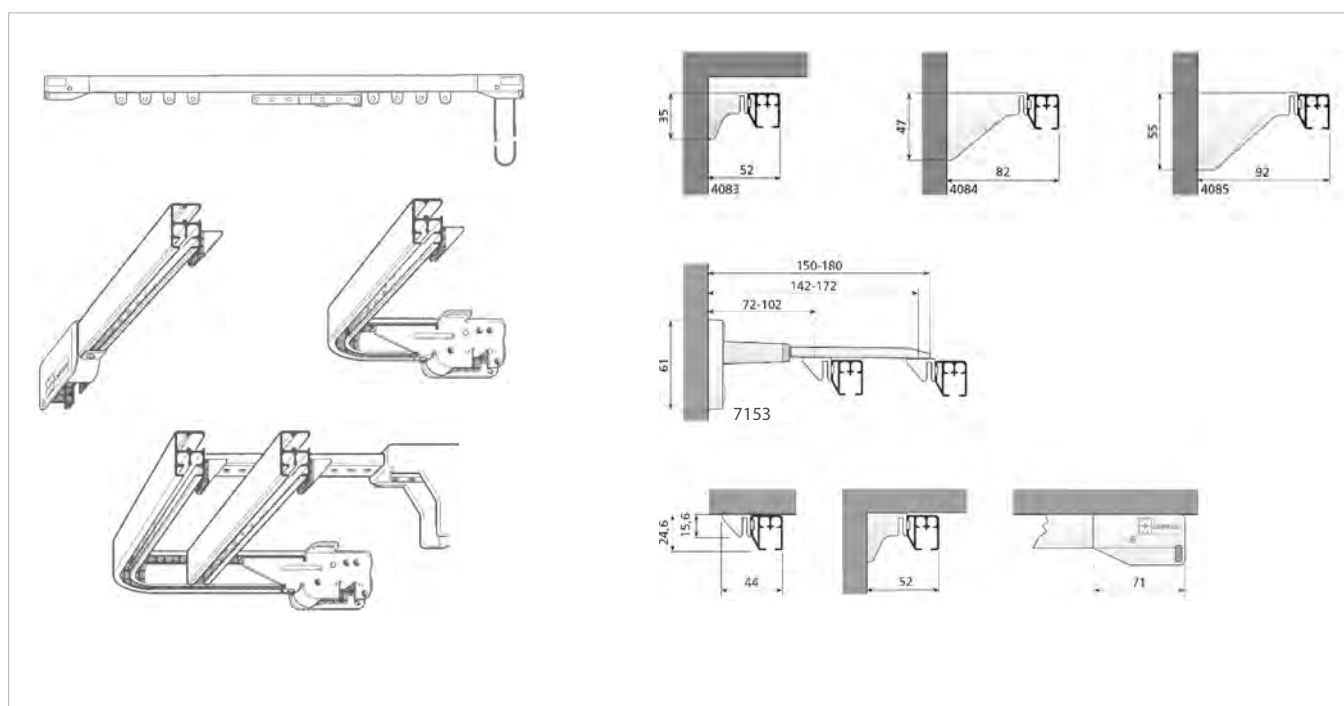
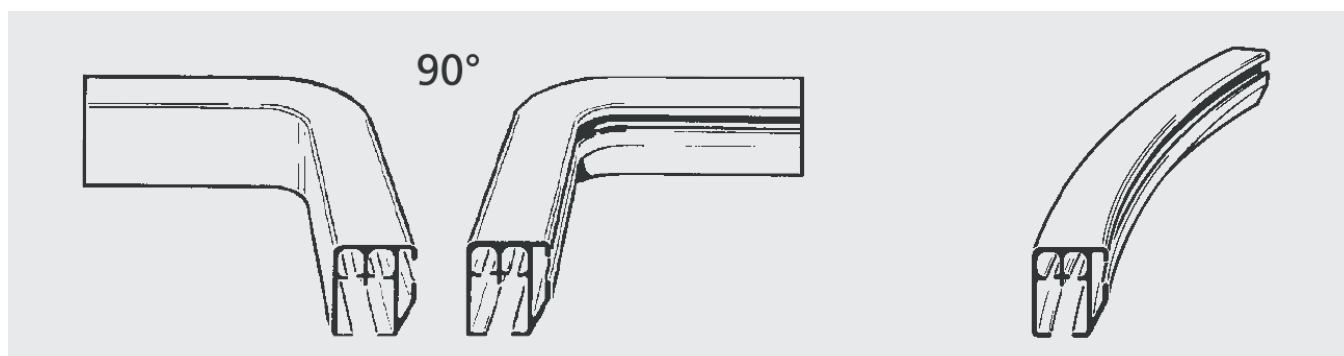

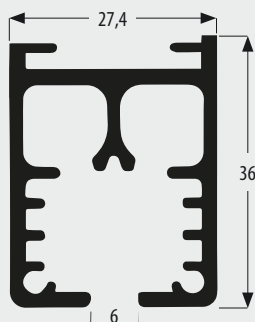

### TECHNISCHE EIGENSCHAFTEN

**FARBEN:** Weiß pulverbeschichtet.

**MONTAGEPUNKTE:** Alle 30 – 60 cm.

**BIEGERADIUS:** Radius bei 90°, 30 cm.

**SONSTIGES:** Standardzubehör Roller mit Stahlachse 5011.

Kugelgelagerte Umlenkrollen aus stoßfestem

Thermoplast. Belastung laut Tabelle.

### GARNITUREN

Inkl.

- ▶ Roller 5011
- ▶ Haken 607
- ▶ Schnellspanner 5234
- ▶ Schnurhalter 8003
- ▶ Feststeller 3295
- ▶ Überlaufwagen 5540

### GARNITUREN WAVE

Inkl.

- ▶ WAVE Roller 5005
- ▶ WAVE Gleiterabstand 8 cm
- ▶ Schnellspanner 5234
- ▶ Schnurhalter 8003
- ▶ Haken 607
- ▶ Feststeller 3295
- ▶ Überlaufwagen 5540

BREITE CM	ANZAHL ROLLER	WAVE ANZAHL ROLLER
200	20	26
250	25	32
300	30	38
350	35	44
400	40	50
450	45	58
500	50	64
550	55	70
600	60	76
650	65	82
700	70	88
750	75	94
800	80	100
850	85	108
900	90	114
950	95	120
1000	100	126
1050	105	132
1100	110	138
1150	115	144
1200	120	150
1250	125	156
1300	130	162
1350	135	168
1400	140	176
1450	145	182
1500	150	188
1550	155	194
1600	160	200

### BELASTUNGSTABELLE FÜR GERADE ANLAGEN

Jeder Bogen reduziert das Behanggewicht um 25 %.

		Meter							
	MIT ROLLER 5011	2	4	6	8	10	12	14	16
KG		10	38	50	50	50	43	25	15

		ART. NR.	VPE
	Weiß	202	1 x 6 m
	Überlaufwagen mit kugelgelagerten Rollen	5540	1
	Profilverbinder	4057	1
	Schnellspanner mit Unterlegscheibe	5234	1
	Wandträger 15 – 19 cm		
	Weiß	7153	1
	Grau	7152	1
	Wandträger Metall ausziehbar		
	Weiß 100 - 150 mm	59312	1
	Verzinkt 100 - 150 mm	59313	1
	Weiß 150 - 230 mm	59326	1
	Verzinkt 150 - 230 mm	59327	1
	Abdeckkappe für Montagewinkel	2390	1
	Schnurbeschwerer 650 g	5088	1
	Schnurbeschwerer 230 g	5001	1
	Schnurspanner Metall Weiß	8001	1
	Schnurspanner Kunststoff Weiß	8002	1
	Schnurspanner Metall XXL	8004	1

		ART. NR.	VPE
	Haken Metall 20 mm	607	10
	Haken Metall 40 mm	608	10
	Roller mit drehbarer Öse	5010	10
	Schwerlastroller mit Stahlachse	5011	10
	Roller mit Kugellager	5028	10
	Roller mit Gummirollen und Stahlachse	6011	10
	Feststeller inkl. Zubehör	4211	1
	Schnur- und Kettenhalter Transparent	8003	1

WAVE ZUBEHÖR

	WAVE Roller	5005	1 m
--	-------------	------	-----



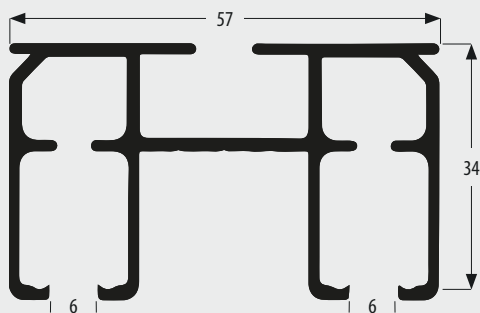

### TECHNISCHE EIGENSCHAFTEN

**FARBEN:** Weiß pulverbeschichtet.

**BEFESTIGUNG:** Profil vorgebohrt.

**MONTAGEPUNKTE:** Alle 30 – 60 cm.

**SONSTIGES:** Belastung laut Tabelle.

### GARNITUREN

Inkl.

- ▶ Roller 5011
- ▶ Haken 607
- ▶ Schnurhalter 8003  
oder
- ▶ Schnurbeschwerer 5001



BREITE CM	ANZAHL ROLLER
200	20
250	25
300	30
350	35
400	40
450	45
500	50
550	55
600	60
650	65
700	70
750	75
800	80
850	85
900	90
950	95
1000	100
1050	105
1100	110
1150	115
1200	120
1250	125
1300	130
1350	135
1400	140
1450	145
1500	150
1550	155
1600	160

### BELASTUNGSTABELLE

		Meter							
	Mit Roller 5011	2	4	6	8	10	12	14	16
KG		10	18	25	35	40	40	35	25



		ART. NR.	VPE
	Weiß	404	1 x 6 m
	Profilverbinder	5087	1
	Schnurbeschwerer 650 g	5088	1
	Schnurbeschwerer 230 g	5001	1
	Schnurspanner Metall Chrom	8000	1
	Weiß	8001	1
	Wandträger Metall ausziehbar		
	Weiß 100 - 150 mm	59312	1
	Verzinkt 100 - 150 mm	59313	1
	Weiß 150 - 230 mm	59326	1
	Verzinkt 150 - 230 mm	59327	1
	Abdeckkappe für Wandträger	2390	1

		ART. NR.	VPE
	Schnurspanner Kunststoff Weiß	8002	1
	Schnurspanner Metall XX	8004	1
	Haken Metall 20 mm	607	10
	Haken Metall 40 mm	608	10
	Schwerlastroller mit Stahlachse	5011	10
	Roller mit Gummirollen und Stahlachse	6011	10
	Roller mit drehbarer Öse	5010	10
	Schnur- und Kettenhalter Transparent	8003	1

