

## Schnurzugschiene für Store oder Übergardine bis max. 8 kg

### Technische Eigenschaften

Farben: weiß-pulverbeschichtet und silber E6 EV1 eloxiert.  
Umlenkrollen aus stoßfestem Thermoplast mit Rollen auf Stahlachsen.

Kleinster Biegeradius bei 90° Bögen 11 cm.

Montagepunkte alle 30 – 60 cm.

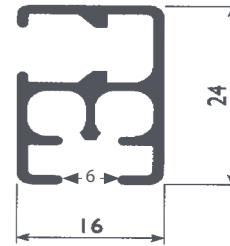

### Garnituren

Inkl. Gleiter 4263, Haken 605, Feststeller 4277, Deckenträger 4081, Wahlweise Schnurhalter 8003 oder Schnurbeschwerer 5001, 1 Überlaufwagen 4185.



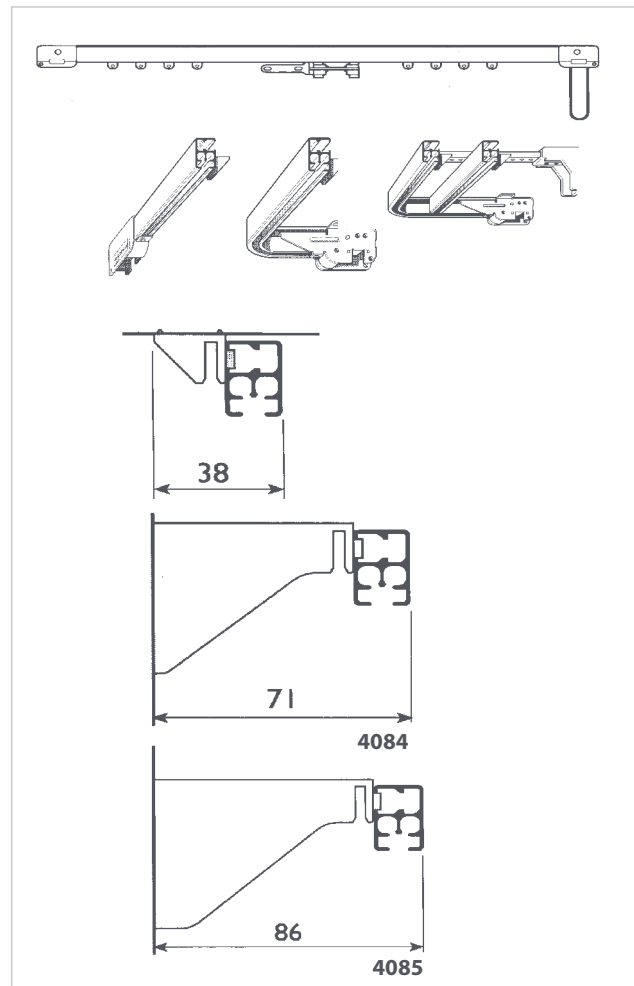



Breite in cm	Anzahl Gleiter
200	32
220	35
240	38
260	42
280	45
300	48
320	51
340	54
360	58
380	61
400	64
420	67
440	70
450	72
460	74
480	77
500	80
520	83
540	86
560	90
580	93
600	96



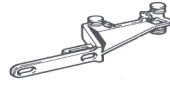

BESTELLN.R.	VPE	
430 weiß/alu	10 x 6 m	

BESTELLN.R.	VPE
<b>Kombiträger 3cm</b>	
 4083	10
<b>Deckenträger 3 cm</b>	
 4081	10
<b>Wandträger</b>	
 4084 4085	5,5 cm 7,5 cm
<b>Wandträger 15 – 19 cm</b>	
 7153 weiß 7152 grau	2
<b>Wandträger Metall, ausziehbar</b>	
 100-150 mm 100-150 mm 150-230 mm 150-230 mm	weiß verzinkt weiß verzinkt
<b>Abdeckkappe für Montagewinkel</b>	
 2390 weiß/grau	1
<b>Schnurbeschwerer 230 g</b>	
 5001 weiß	1
<b>Schnur- und Kettenhalter</b>	
 8003 transparent	10

BESTELLN.R.	VPE
<b>Gelenkgleiter</b>	
 926	100
<b>Spalthaken</b>	
 605	100
<b>Einfachhaken</b>	
 385	100
<b>Stopper mit Metallkralle</b>	
 4277	100
<b>Verschluss-Stopfen</b>	
 918L	100
<b>Überlaufwagen</b>	
 4185	1
<b>Schnurspanner Kunststoff</b>	
 8002 weiß	1
<b>Schnurspanner Metall</b>	
 8000 verzinkt 8001 weiß	1