

Schnurzugschiene für leichte und mittelschwere Vorhänge

Technische Eigenschaften

Farben: Profil in weiß und silber E6 EV1 eloxiert lieferbar.
Ab 100 cm Radius geeignet für Montage im Bogenfenster.
Alle 24 cm vorgebohrt.

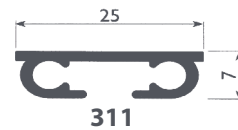

311



322

Garnituren

Inkl. Gleiter 4263, Haken 605, Feststeller 4277, Montage-Clip 4388 (nur Schiene 311), wahlweise Schnurhalter 8003 oder Schnurbeschwerer 5001, Überlaufwagen 4185 (für Schiene 311)

311/322

Breite in cm	Anzahl Gleiter
200	32
220	35
240	38
260	42
280	45
300	48
320	51
340	54
360	58
380	61
400	64
420	67
430	69
440	70
450	72
460	74
480	77
500	80
520	83
540	86
560	90
580	93
600	96

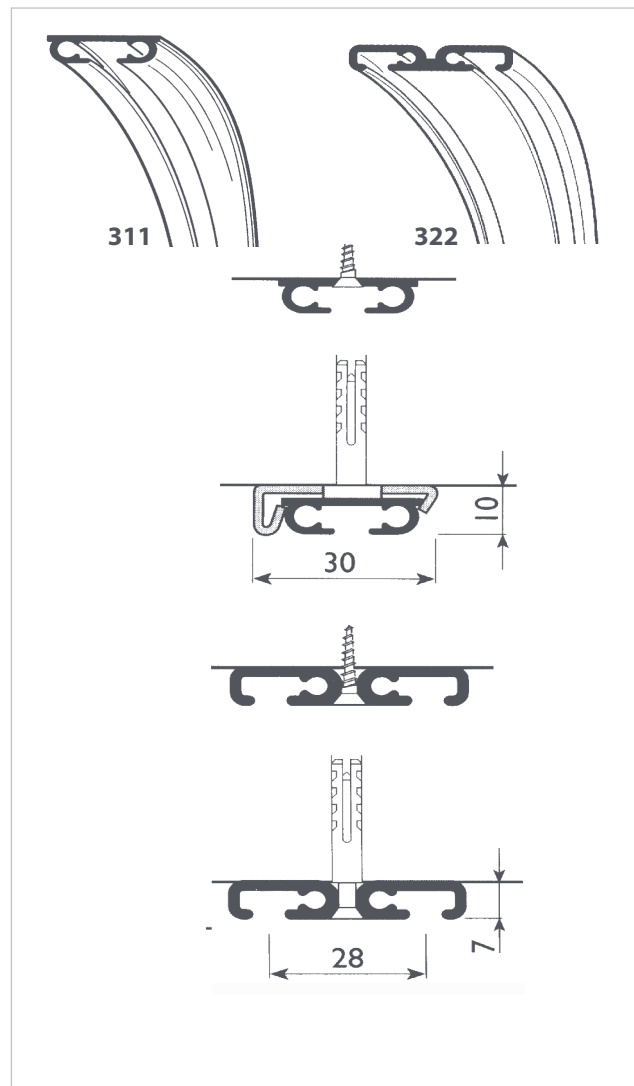



	BESTELLN.R.	VPE	
	311 weiß/alu	10 x 6 m	

	BESTELLN.R.	VPE	
	322 weiß/alu	10 x 6 m	

BESTELLN.R.	VPE
-------------	-----

Montage-Clip Metall	
	4388 10

Verschluss-Stopfen (6 mm)	
	918L 100

Schraube mit Dübel	
	4389 100

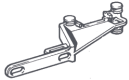
Überlaufwagen	
	4185 1

Schnurbeschwerer 180 g	
	4001 weiß 1

Schnurbeschwerer 230 g	
	5001 weiß 1

Schnurspanner Kunststoff	
	8002 weiß 1

Schnurspanner Metall	
	8000 chrom 8001 weiß 1

BESTELLN.R.	VPE
-------------	-----

Gleiter (10 Stück) auf Stange (6 mm)	
	4263 weiß 100

Spalthaken	
	605 100

Einfachhaken	
	385 100

Gelenkgleiter (6 mm)	
	926 100

Stopper mit Metallkralle (6 mm)	
	4277 100

Verschluss-Stopfen (6 mm)	
	918L 100

Schnur- und Kettenhalter	
	8003 transparent 1