



Raumtrennschienen

Raumtrennschienen

Raumtrennschiene für Kabinen-, Bad- und Duschtrennungen

Technische Eigenschaften

Geeignet auch für schwere Vorhänge.
Einsatz von Gleitern und Rollern möglich.

Farben: weiß und silber E6 EV1 eloxiert.
Decken-Wand sowie abgehängte Montage möglich. Kleinster Radius bei 90°; Kurven 25 cm; Montagepunkte ca. alle 50 cm.

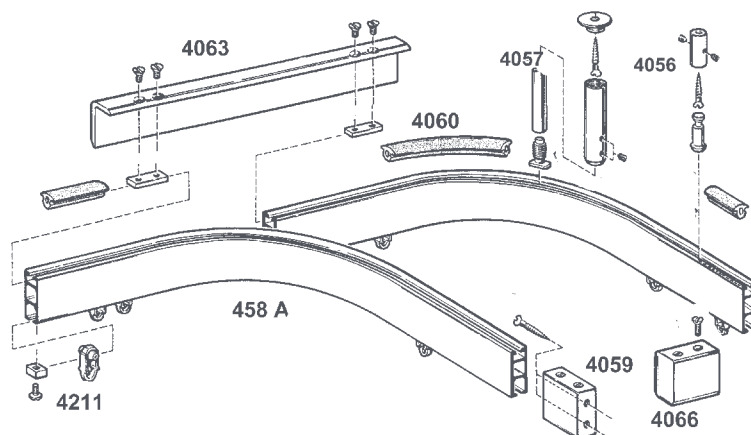







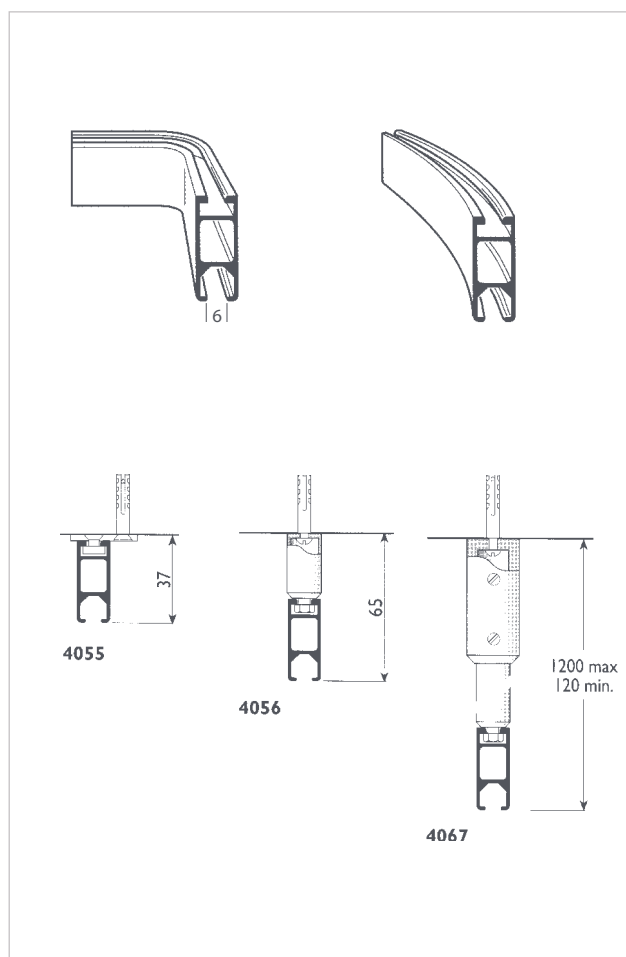



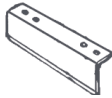

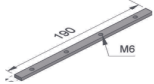

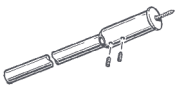
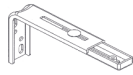

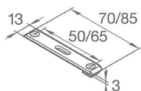

Garnituren

Inkl. Gleiter 4263, Haken 605, Deckenträger 4055, Enddeckel 4066.

| Breite in cm | Anzahl Gleiter |
|--------------|----------------|
| 200 | 32 |
| 210 | 34 |
| 220 | 36 |
| 230 | 38 |
| 240 | 38 |
| 250 | 40 |
| 260 | 42 |
| 270 | 44 |
| 280 | 46 |
| 290 | 46 |
| 300 | 48 |
| 310 | 50 |
| 320 | 52 |
| 330 | 52 |
| 340 | 54 |
| 350 | 56 |
| 360 | 58 |
| 370 | 60 |
| 380 | 62 |
| 390 | 64 |
| 400 | 64 |
| 410 | 66 |
| 420 | 68 |
| 430 | 70 |
| 440 | 72 |
| 450 | 72 |
| 460 | 74 |
| 470 | 76 |
| 480 | 78 |
| 490 | 78 |
| 500 | 80 |

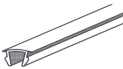
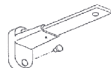

| | BESTELLN.R. | VPE | | BESTELLN.R. | VPE |
|--|--|--------------------------------------|--|-------------|-----|
|  | 458 weiß/alu | 10 x 6 m | | | |
| Wandlager | | | | | |
|  | 4059 weiß/alu | 1 | | | |
| Brücke | | | | | |
|  | 4064 weiß/alu | 1 | | | |
| Kreuzverbinder | | | | | |
|  | 4065 weiß/ verzinkt | 1 | | | |
| Deckenträger | | | | | |
|  | 4055 weiß/silber | 10 | | | |
| Profilverbinder | | | | | |
|  | 906 | 1 | | | |
| Deckenabhängiger 3 cm | | | | | |
|  | 4056 weiß/alu | 1 | | | |
| Deckenhänger 100 cm | | | | | |
|  | 4057 weiß/alu Jede weiteren | 1 10 cm | | | |
| Wandträger Metall, ausziehbar | | | | | |
|  | 100-150 mm 100-150 mm 150-230 mm 150-230 mm | weiß verzinkt weiß verzinkt | | | |
| Abdeckkappe für Montagewinkel | | | | | |
|  | 2390 weiß/grau | 1 | | | |
| Deckenträger 2-läufig 50 und 75 mm Laufabstand | | | | | |
|  | 4067 weiß 4068 alu 4069 weiß 4070 alu | 50 mm 50 mm 70 mm 70 mm | | | |
| Objektroller | | | | | |
|  | 996 | 100 | | | |
| Gelenkgleiter (6 mm) | | | | | |
|  | 926 | 100 | | | |
| Gleiter (10 Stück) auf Stange (6 mm) | | | | | |
|  | 4263 weiß | 100 | | | |
| Roller mit Nylonachse | | | | | |
|  | 4144 | 100 | | | |
| Roller mit Stahlachse | | | | | |
|  | 4330 | 100 | | | |
| Haken Metall 20 mm | | | | | |
|  | 607 | 100 | | | |
| Spalthaken | | | | | |
|  | 605 | 100 | | | |
| Einfachhaken | | | | | |
|  | 385 | 100 | | | |
| Stopper Kunststoff (6 mm) | | | | | |
|  | 4277 | 100 | | | |
| Enddeckel Kunststoff | | | | | |
|  | 4066 weiß/grau | 1 | | | |
| Abdeckkeder | | | | | |
|  | 4060 transparent | 1 | | | |
| Wandträger 15 - 19 cm | | | | | |
|  | 7153 weiß 7152 grau | 1 | | | |

Raumtrennschiene für Kabinen-, Bad- und Duschtrennungen

Technische Eigenschaften

Farben: weiß-pulverbeschichtet und silber E6 EV1 eloxiert.

Kleinster Biegeradius bei 90° Bögen 25 cm.

Einsatz von einfachen Rollern möglich.

Montagepunkte alle 40 – 80 cm.









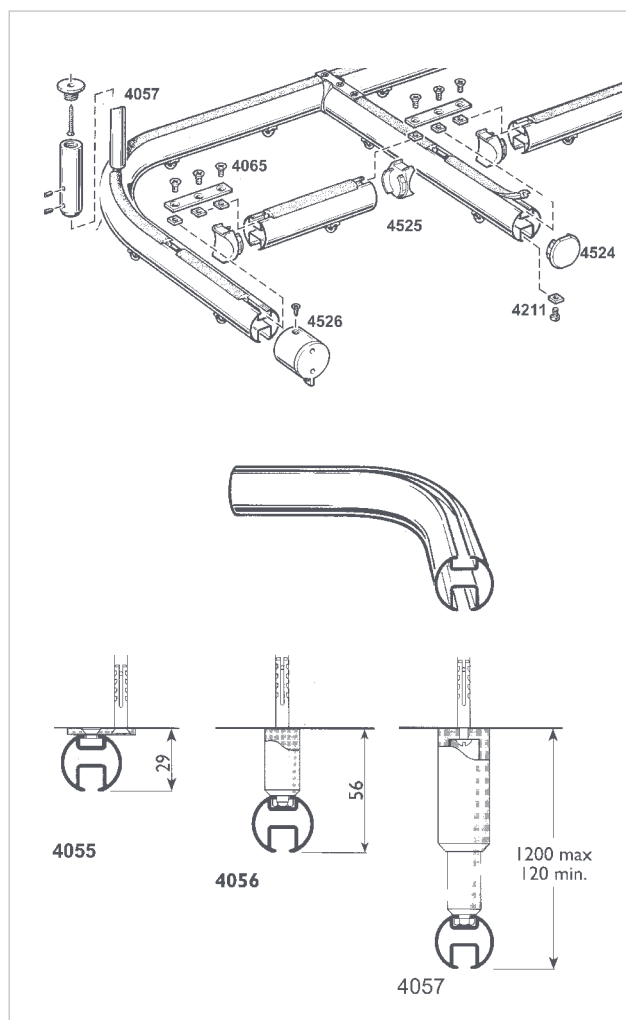





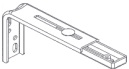



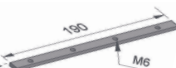

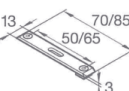



Garnituren

Inkl. Feststeller, Gleiter 4263, Haken 605, Enddeckel 4524, Deckenträger 4055.

| Breite in cm | Anzahl Gleiter |
|--------------|----------------|
| 200 | 32 |
| 210 | 34 |
| 220 | 36 |
| 230 | 38 |
| 240 | 38 |
| 250 | 40 |
| 260 | 42 |
| 270 | 44 |
| 280 | 46 |
| 290 | 46 |
| 300 | 48 |
| 310 | 50 |
| 320 | 52 |
| 330 | 52 |
| 340 | 54 |
| 350 | 56 |
| 360 | 58 |
| 370 | 60 |
| 380 | 62 |
| 390 | 64 |
| 400 | 64 |
| 410 | 66 |
| 420 | 68 |
| 430 | 70 |
| 440 | 72 |
| 450 | 72 |
| 460 | 74 |
| 470 | 76 |
| 480 | 78 |
| 490 | 78 |
| 500 | 80 |

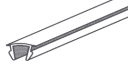

| | BESTELNR. | VPE | | BESTELNR. | VPE |
|--|--|--------------------------------------|--|-----------|-----|
|  | 464 weiß/alu | 10 x 6 m | | | |
| Deckenträger | | | | | |
|  | 4055 weiß/silber | 10 | | | |
| Deckenabhängiger 3 cm | | | | | |
|  | 4056 weiß/alu | 1 | | | |
| Deckenhänger 100 cm | | | | | |
|  | 4057 weiß/alu Jede weiteren | 1 10 cm | | | |
| Wandträger Metall, ausziehbar | | | | | |
|  | 100-150 mm 100-150 mm 150-230 mm 150-230 mm | weiß verzinkt weiß verzinkt | | | |
| Abdeckkappe für Montagewinkel | | | | | |
|  | 2390 weiß/grau | 1 | | | |
| Wandträger 15 - 19 cm | | | | | |
|  | 7153 weiß 7152 grau | 1 | | | |
| Kreuzverbinder | | | | | |
|  | 4065 weiß/ verzinkt | 1 | | | |
| Profilverbinder | | | | | |
|  | 906 | 1 | | | |
| Anschlußverbinder | | | | | |
|  | 4025 | 1 | | | |
| Wandlager | | | | | |
|  | 4526 weiß/grau | 1 | | | |
| Deckenträger 2-läufig 50 und 75 mm Laufabstand | | | | | |
|  | 4067 weiß 4068 alu 4069 weiß 4070 alu | 50 mm 50 mm 70 mm 70 mm | | | |
| Objektroller | | | | | |
|  | 996 | 100 | | | |
| Gelenkgleiter (6 mm) | | | | | |
|  | 926 | 100 | | | |
| Gleiter (10 Stück) auf Stange (6 mm) | | | | | |
|  | 4263 weiß | 100 | | | |
| Roller mit Stahlachse | | | | | |
|  | 4330 | 100 | | | |
| Roller mit Nylonachse | | | | | |
|  | 4144 | 100 | | | |
| Haken Metall 20 mm | | | | | |
|  | 607 | 100 | | | |
| Spalthaken | | | | | |
|  | 605 | 100 | | | |
| Einfachhaken | | | | | |
|  | 385 | 100 | | | |
| Stopper mit Metallkralle (6 mm) | | | | | |
|  | 4277 | 100 | | | |
| Abdeckkeder | | | | | |
|  | 4060 transparent | 1 | | | |
| Brücke | | | | | |
|  | 4528 weiß/alu | 1 | | | |
| Enddeckel Kunststoff | | | | | |
|  | 4524 | 1 Paar | | | |