

## Schleuderschiene für leichte Store oder Übergardine

### Technische Eigenschaften

Farben: weiß-pulverbeschichtet und silber E6 EV1 eloxiert.

Deckenmontage mit versenkten Spannern oder Clips.

Kleinster Biegeradius bei 90°, 8 cm.

Montagepunkte alle 30 – 40 cm.

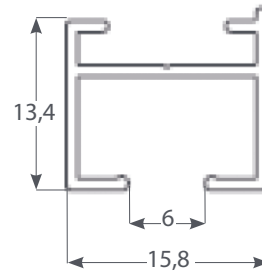

### Garnituren





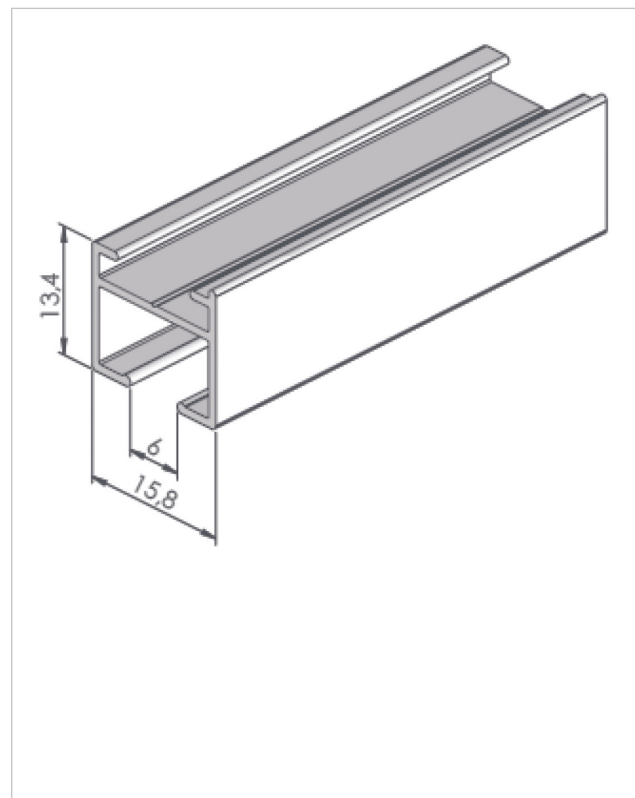

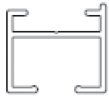
Inkl. Gleiter 4263, Haken 605, Feststeller 4277, Schnellspanner 170, Enddeckel 402.

Breite in cm	Anzahl Gleiter
200	32
210	34
220	36
230	38
240	38
250	40
260	42
270	44
280	46
290	46
300	48
310	50
320	52
330	52
340	54
350	56
360	58
370	60
380	62
390	64
400	64
410	68
430	70
440	72
450	72

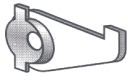

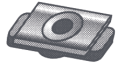

BESTELLNR.	VPE
<b>401</b> weiß/alu	<b>1 x 6 m</b> <b>10 x 6 m</b> <b>20 x 6 m</b>

	BESTELLNR.	VPE
<b>Enddeckel</b>		
	402	1 Paar
<b>Schnellspanner Kunststoff</b>		
	170	100
<b>Schnellspanner Metall mit Unterlegscheibe</b>		
	4521	50
<b>Deckenclip</b>		
	175	100
<b>Profilverbinder</b>		
	172	1
<b>Gleiter (10 Stück) auf Stange (6 mm)</b>		
	4263 weiß	100
<b>Spalthaken</b>		
	605	100
<b>Einfachhaken</b>		
	385	100

	BESTELLNR.	VPE
<b>Click-Gleiter (6 mm)</b>		
	400	100
<b>Click-Gleiter mit Haken (6 mm)</b>		
	310	100
<b>Gelenkgleiter (6 mm)</b>		
	926	100
<b>Objektroller</b>		
	996	100
<b>Roller mit Stahlachse</b>		
	4330	100
<b>Roller mit Nylonachse</b>		
	4144	100
<b>Stopper mit Metallkralle (6 mm)</b>		
	4277	100
<b>Verschluss-Stopfen (6 mm)</b>		
	918L	100